



BM05P06B

主要参数 MAIN CHARACTERISTICS

I_C	-5A
V_{CE0}	-60V
P_C	550mW

用途

- 静音开关
- 电池充电器
- 线性开关电源
- 电机驱动器

APPLICATIONS

- Switching and muting
- Battery charger
- Supply line switching circuits
- motor drivers

产品特性

- 硅外延
- 饱和压降低，电流大
- 与 BM05N06B 互补
- 环保 (RoHS) 产品

FEATURES

- Epitaxial silicon
- Low $V_{CE(sat)}$, high current
- Complementary to BM05N06B
- RoHS product

封装 Package

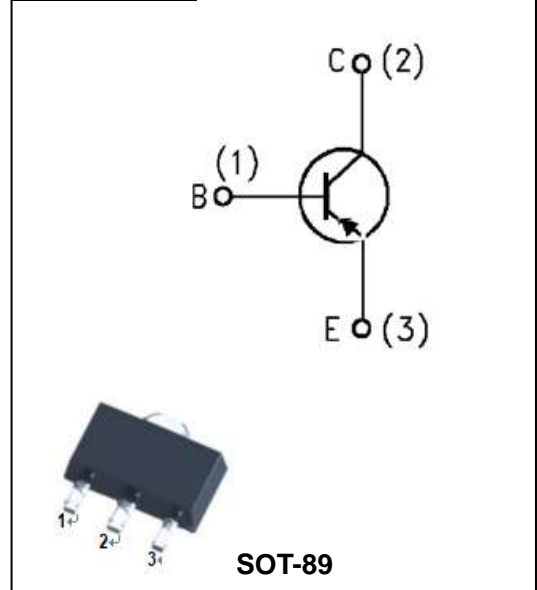

订货信息 ORDER MESSAGE

订货型号 Order codes				印 记 Marking	封 装 Package
有卤-条管 Halogen-Tube	无卤-条管 Halogen Free-Tube	有卤-编带 Halogen-Reel	无卤-编带 Halogen Free-Reel		
NA	N/A	N/A	BM05P06B-NB-AR	05P06	SOT-89

绝对最大额定值 ABSOLUTE RATINGS ($T_C=25^{\circ}\text{C}$)

项 目 Parameter	符 号 Symbol	数 值 Value	单 位 Unit	
集电极—基极直流电压	Collector- Base Voltage ($I_E=0$)	V_{CBO}	-60	V
集电极—发射极直流电压	Collector- Emitter Voltage ($I_B=0$)	V_{CEO}	-60	V
发射极—基极直流电压	Emitter-Base Voltage ($I_C=0$)	V_{EBO}	-5	V
最大集电极直流电流	Collector Current (DC)	I_C	-5	A
最大集电极耗散功率	Total Dissipation	P_C	550	mW
最高结温	Junction Temperature	T_j	150	$^{\circ}\text{C}$
贮存温度	Storage Temperature	T_{stg}	-55~+150	$^{\circ}\text{C}$

电特性 ELECTRICAL CHARACTERISTIC

项 目 Parameter	测试条件 Tests conditions	最小值 Value(min)	最大值 Value(max)	单 位 Unit
BV_{CBO}	$I_C=-100\text{ uA}$,	-60		V
BV_{CES}	$I_C=-100\text{ uA}$,	-60		V
BV_{CEO}	$I_C=-10\text{mA}$	-60		V
BV_{EBO}	$I_E=-100\text{uA}$, $I_C=0$	-7		V
I_{CBO}	$V_{CB}=-60\text{V}$, $I_E=0$		-100	nA
I_{CES}	$V_{CB}=-48\text{V}$, $I_E=0$		-100	nA
I_{EBO}	$V_{EB}=-5\text{V}$, $I_C=0$		-100	nA
$h_{FE}(1)$	$V_{CE}=-2\text{V}$, $I_C=-500\text{mA}$	200		
$h_{FE}(2)$	$V_{CE}=-2\text{V}$, $I_C=-1\text{A}$	180		
$h_{FE}(3)$	$V_{CE}=-2\text{V}$, $I_C=-2\text{A}$	150		
$h_{FE}(4)$	$V_{CE}=-2\text{V}$, $I_C=-4\text{A}$	120		
$h_{FE}(5)$	$V_{CE}=-2\text{V}$, $I_C=-6\text{A}$	80		
V_{cesat1}	$I_C=-1\text{A}$, $I_B=-50\text{mA}$		-90	mV
V_{cesat2}	$I_C=-1\text{A}$, $I_B=-10\text{mA}$		-190	mV
V_{cesat3}	$I_C=-2\text{A}$, $I_B=-40\text{mA}$		-230	mV
V_{cesat4}	$I_C=-4\text{A}$, $I_B=-200\text{mA}$		-300	mV
V_{cesat5}	$I_C=-4\text{A}$, $I_B=-400\text{mA}$		-240	mV
V_{cesat6}	$I_C=-5\text{A}$, $I_B=-500\text{mA}$		-300	mV
V_{besat1}	$I_C=-1\text{A}$, $I_B=-100\text{ mA}$		-0.9	V
V_{besat2}	$I_C=-4\text{A}$, $I_B=-400\text{ mA}$		-1.05	V
V_{beon}	$V_{CE}=-2\text{V}$, $I_C=-2\text{A}$		-0.85	V



热特性 THERMAL CHARACTERISTIC

项 目 Parameter	符 号 Symbol	最小值 Value(min)	最大值 Value(max)	单 位 Unit
结到环境的热阻 Thermal Resistance, Junction-to-Ambient	$R_{th(j-a)}$	-	225	$^{\circ}C/W$
结到环境的热阻 (a) Thermal Resistance, Junction-to-Ambient	$R_{th(j-a)}$	-	83	$^{\circ}C/W$

(a) For a device surface mounted on 25mm x 25mm x 1.6mm FR4 PCB with high coverage of single sided 35um copper, in still air conditions.





特征曲线 ELECTRICAL CHARACTERISTICS (curves)

$hFE - I_C$

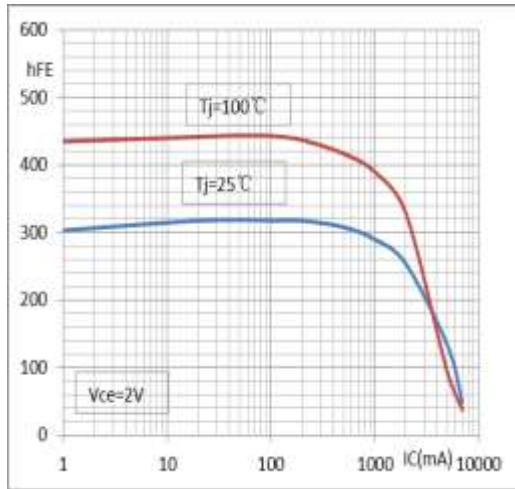

$V_{BEon} - I_C$

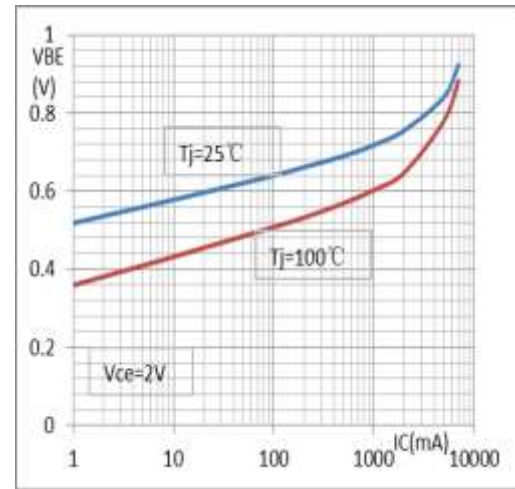

$V_{CE(sat)} - I_C$

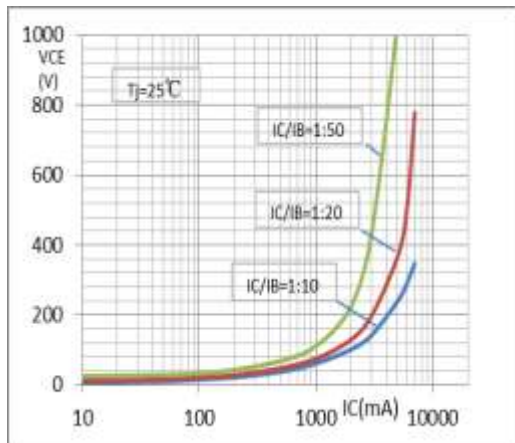

$V_{CE(sat)} - I_C$

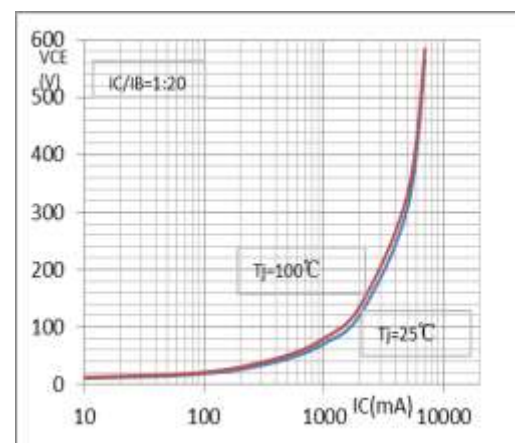

$V_{BE(sat)} - I_C$

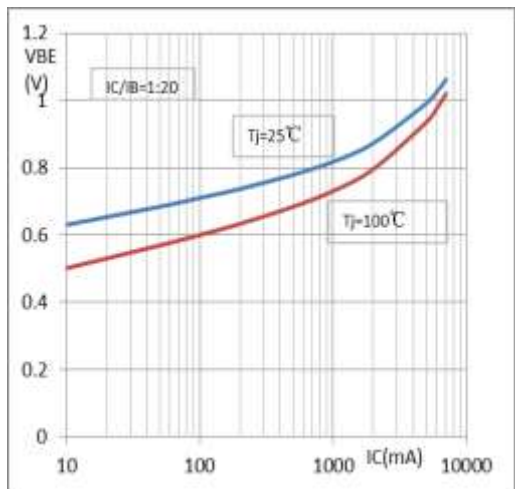

SOA

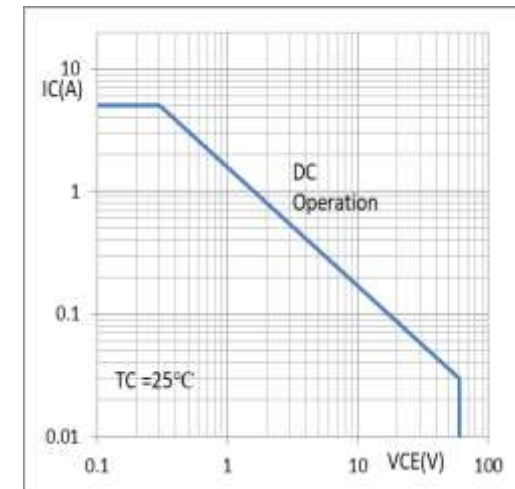

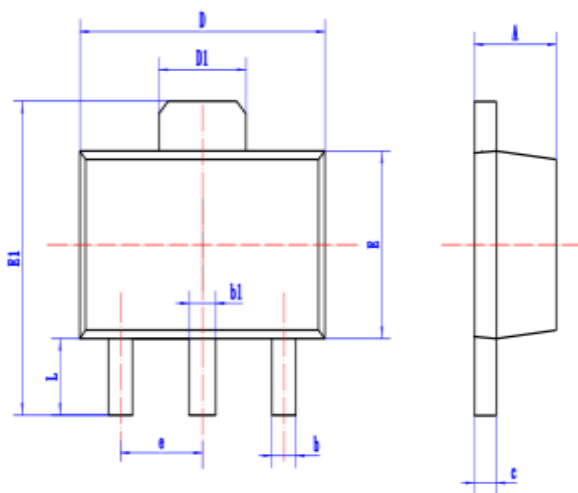

SYMBOL	MM	
	MIN	MAX
A	1.30	1.70
b	0.30	0.55
b1	0.35	0.65
c	0.30	0.50
D	4.30	4.70
D1	1.55 REF	
E	2.30	2.60
E1	3.90	4.30
e	1.50 TYP	
L	0.80	1.20





注意事项

1. 吉林华微电子股份有限公司的产品销售分为直销和销售代理，无论哪种方式，订货时请与公司核实。
2. 购买时请认清公司商标，如有疑问请与公司本部联系。
3. 在电路设计时请不要超过器件的绝对最大额定值，否则会影响整机的可靠性。
4. 本说明书如有版本变更不另外告知。

NOTE

1. Jilin Sino-microelectronics co., Ltd sales its product either through direct sales or sales agent , thus, for customers, when ordering , please check with our company.
2. We strongly recommend customers check carefully on the trademark when buying our product, if there is any question, please don't be hesitate to contact us.
3. Please do not exceed the absolute maximum ratings of the device when circuit designing.
4. Jilin Sino-microelectronics co., Ltd reserves the right to make changes in this. specification sheet and is subject to change without prior notice.

联系方式

吉林华微电子股份有限公司

公司地址：吉林省吉林市深圳街 99 号

邮编：132013

总机：86-432-64678411

传真：86-432-64665812

网址：www.hwdz.com.cn

CONTACT

JILIN SINO-MICROELECTRONICS CO., LTD.

ADD: No.99 Shenzhen Street, Jilin City, Jilin Province, China.

Post Code: 132013

Tel: 86-432-64678411

Fax: 86-432-64665812

Web Site: www.hwdz.com.cn