

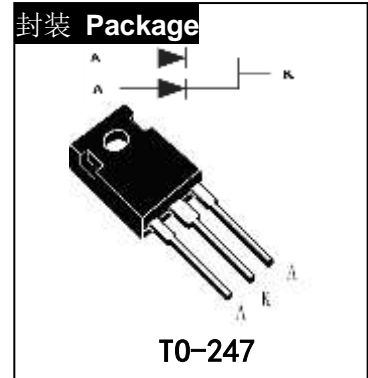

60F60W3T

主要参数 MAIN CHARACTERISTICS

$I_F(AV)$	$30 \times 2 A$
V_{RRM}	600 V
$V_F(\text{typ})$	2.0V
$T_{rr}(\text{typ})$	25ns



用途

- 有源 PFC
- 开关电源
- 光伏逆变
- UPS

APPLICATIONS

- Active PFC
- Switch power supply
- Photovoltaic inverter
- UPS

产品特性

- 超快恢复时间
- 低恢复损耗
- 低漏电流

FEATURES

- Ultrafast Recovery Time
- Low Recovery Loss
- Low Leakage Current

订货信息 ORDER MESSAGE

订货型号 Order codes		印 记 Marking	封 装 Package
有卤-条管 Halogen-Tube	无卤-条管 Halogen Free-Tube		
60F60W3T-GE-B	60F60W3T-GE-BR	60F60W3T	TO-247

绝对最大额定值 ABSOLUTE RATINGS ($T_c=25^\circ\text{C}$)

项 目 Parameter	符 号 Symbol	数 值 Value	单 位 Unit
反向重复峰值电压 Peak Repetitive Reverse Voltage	V_{RRM}	600	V
平均正向整流电流 $T_c=110^\circ\text{C}$ Average Forward Rectified Current	$I_{F(AV)}$	60	A
		30	
非重复浪涌正向电流 Non-Repetitive Surge Forward Current $t=10\text{ms}$	I_{FSM}	300	A
结温 Junction Temperature	T_j	-55~+175	$^\circ\text{C}$
储存温度 Storage temperature range	T_{STG}	-55~+150	$^\circ\text{C}$

电特性 ELECTRICAL CHARACTERISTICS ($T_c=25^\circ\text{C}$ unless otherwise specified)

项 目 Parameter	测试条件 Tests conditions		最小值 Value(min)	典型值 Value(typ)	最大值 Value(max)	单位 Unit
V_R	$I_R=50\mu\text{A}$		600	-	-	V
I_R	$T_j=25^\circ\text{C}$	$V_R=V_{RRM}$	-	-	10	μA
	$T_j=125^\circ\text{C}$		-	-	500	μA
V_F	$T_j=25^\circ\text{C}$	$I_F=30\text{A}$ per diode	-	2.0	2.5	V
	$T_j=125^\circ\text{C}$		-	1.7	2.1	V
trr	$I_F=0.5\text{A}, I_R=1\text{A}, I_{RR}=0.25\text{A}$		-	30	40	ns
trr	$I_F=1\text{A}, V_R=30\text{V}, di_F/dt=-100\text{A}/\mu\text{s}$		-	25	30	ns
trr	$I_F=30\text{A}, V_R=200\text{V}, di_F/dt=-200\text{A}/\mu\text{s}$		-	30	-	ns
Qrr	$T_c=25^\circ\text{C}$		-	23	-	nc
I_{RRM}			-	1.5	-	A
trr			-	91	-	ns
Qrr	$T_c=125^\circ\text{C}$		-	173	-	nc
I_{RRM}			-	3.8	-	A

热特性 THERMAL CHARACTERISTICS (per diode)





60F60W3T

项 目 Parameter	符 号 Symbol	最大值 Value(max)	单 位 Unit
结到管壳的热阻 Thermal Resistance Junction to Case	$R_{th(j-c)}$	0.8	$^{\circ}\text{C}/\text{W}$

特征曲线 ELECTRICAL CHARACTERISTICS (curves)

Fig.1 TYPICAL FORWARD CHARACTERISTICS

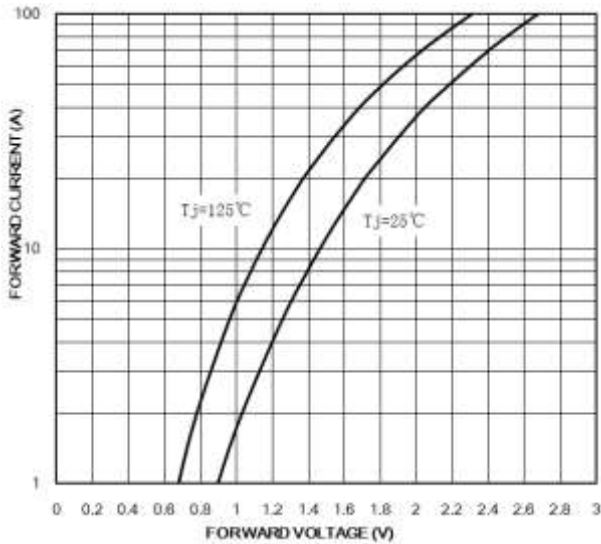

Fig.2 TYPICAL REVERSE CHARACTERISTICS

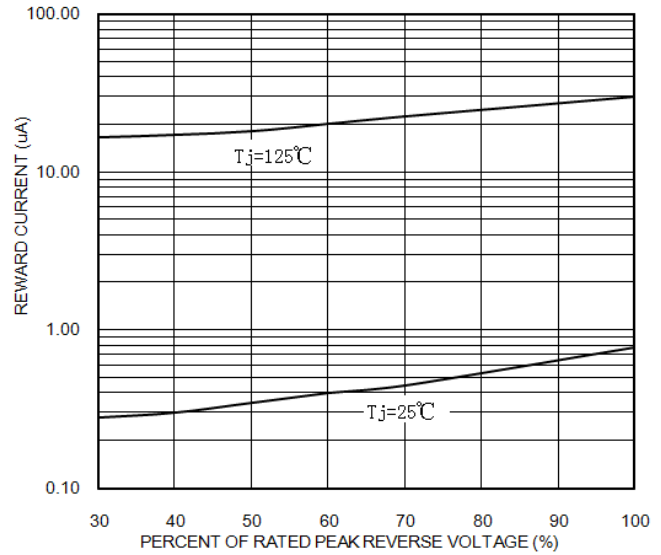

Fig.3 Reverse recovery time versus di/dt

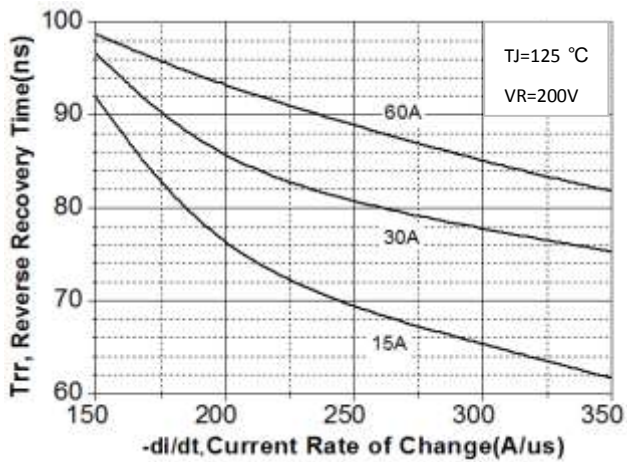

Fig.4 Peak reverse recovery current versus di/dt

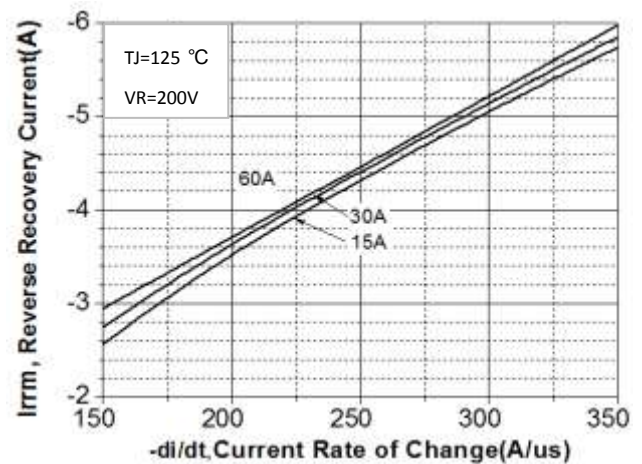

Fig.5 Reverse recovery charges versus di/dt

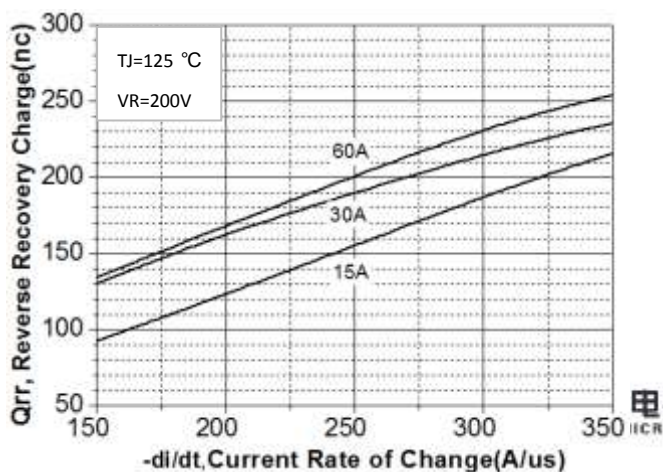
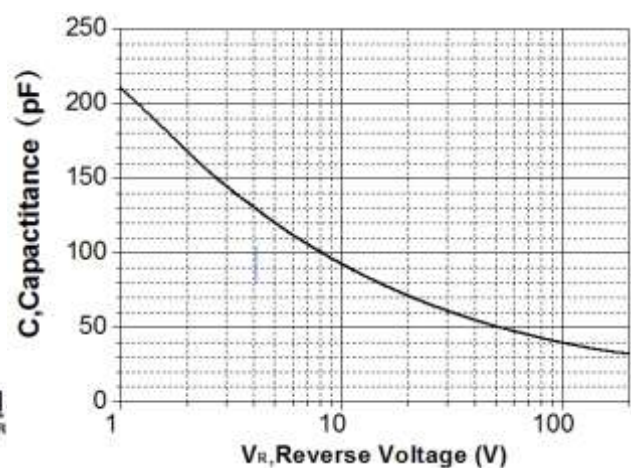

Fig.6 TYPICAL JUNCTION CAPACITANCE



外形尺寸 PACKAGE MECHANICAL DATA

TO-247

单位 Unit : mm

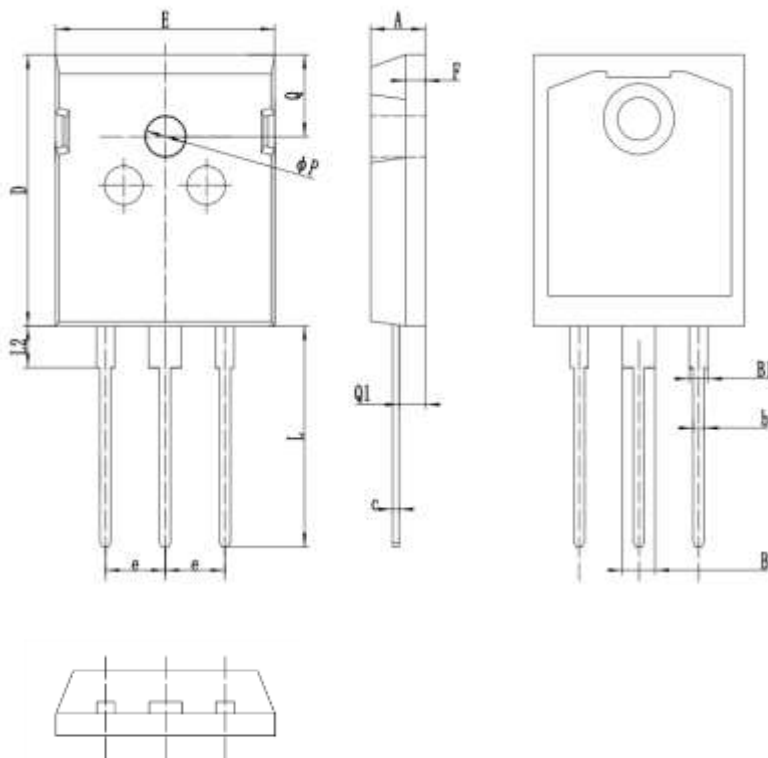

符号 symbol	mm	
	MIN	MAX
A	4.90	5.10
B	2.95	3.35
B1	1.95	2.35
b	1.15	1.35
c	0.50	0.70
D	20.90	21.10
E	15.70	15.90
e	5.34	5.54
F	1.90	2.10
L	19.40	20.40
L2	4.03	4.23
Q1	6.00	6.40
P	2.30	2.50



注意事项

1. 吉林华微电子股份有限公司的产品销售分为直销和销售代理，无论哪种方式，订货时请与公司核实。
2. 购买时请认清公司商标，如有疑问请与公司本部联系。
3. 在电路设计时请不要超过器件的绝对最大额定值，否则会影响整机的可靠性。
4. 本说明书如有版本变更不另外告知。

NOTE

1. Jilin Sino-microelectronics co., Ltd sales its product either through direct sales or sales agent , thus, for customers, when ordering , please check with our company.
2. We strongly recommend customers check carefully on the trademark when buying our product, if there is any question, please don't be hesitate to contact us.
3. Please do not exceed the absolute maximum ratings of the device when circuit designing.
4. Jilin Sino-microelectronics co., Ltd reserves the right to make changes in this. specification sheet and is subject to change without prior notice.

联系方式

吉林华微电子股份有限公司

公司地址：吉林省吉林市深圳街 99 号

邮编：132013

总机：86-432-64678411

传真：86-432-64665812

网址：www.hwdz.com.cn

CONTACT

JILIN SINO-MICROELECTRONICS CO., LTD.

ADD: No.99 Shenzhen Street, Jilin City, Jilin Province, China.

Post Code: 132013

Tel: 86-432-64678411

Fax: 86-432-64665812

Web Site: www.hwdz.com.cn

